

tabou.TM DESIGN
LIVING COLLECTION

tabou.TM DESIGN
LIVING COLLECTION

LIVING COLLECTION



Esto no es un catálogo de muebles. Esto, aunque no lo parezca, sólo son un puñado de ideas para despertar tu imaginación. Aquí no están tus muebles esperando a que vengas a por ellos, estamos nosotros para compartir nuestras propuestas contigo. Nuestro trabajo consiste en observar a la gente y adelantarnos a sus deseos. Por eso no trabajamos para la mayoría, sólo para quienes se sienten únicos.

This is not a furniture catalog. This, although it may not seem like it, are just a handful of ideas to spark your imagination. Your furniture is not here waiting for you to come for them, we are here to share our proposals with you. Our job is to observe people and anticipate their wishes. That is why we do not work for the majority, only for those who feel unique.

tabou™ DESIGN.LIVING

índice
index

MESAS
Tables

06 Korus
20 Pippa
30 Havana
40 Morgan
48 Nora
60 Nomad
72 Kyoto
84 Mikado

SILLAS
Chairs

98 Galan
104 Carmen
106 Logan
112 Ponte
114 Oslo
116 Tamago
126 Romeo
128 Kyoto
132 Nomad
134 Emma
136 Ximena

Konus es el símbolo de la elegancia y el amor por el detalle. Su pie central es un cono hecho con listones de madera maciza de fresno con forma de pequeños remos. Un diseño único que transmite belleza con un ajuste perfecto. El resultado es una mesa escultural para que los amantes del buen diseño puedan descubrir sus detalles.

KONUS



Konus is the symbol of elegance and love for detail. Its central leg is made with solid ash wood slats in the shape of small oars. These perfectly assembled pieces form a beautiful wooden cone. A unique design that conveys beauty with a perfect fit. The result is a sculptural table so that lovers of good design can discover its details.



La versatilidad de Konus es sorprendente. El programa tiene 3 versiones: Single, Inverted y Double. Dentro de cada versión existen varias opciones de formas y múltiples combinaciones de materiales y acabados

Konus' versatility is surprising. The program has 3 versions: Single, Inverted and Double. Within each version there are several shape options and multiple combinations of materials and finishes.

Single, Redonda (R) ó Cuadrada en 3 opciones (C1, C2, C3)
Single, Round (R) or Square in 3 options (C1, C2, C3)



Inverted, Oval (V3) ó Rectangular con dos formatos diferentes (V1, V2)
Inverted, Oval (V3) or Rectangular with two different formats (V1, V2)



Double, Ovalada (D3) ó Rectangular con dos formatos diferentes (D1, D2)
Double, Oval (D3) or Rectangular with two different formats (D1, D2)





KONUS

Konus Inverted Oval V3 - 240x110cm
Top Neolith Amazonic. Base MF52 Grigio

Oslo Chair
Asiento MA00. Estructura MH52 Grigio



■ KONUS

La mesa Konus Oval presenta la base cónica invertida con un embellecedor inferior circular de madera y una base metálica ovalada de acero que le proporciona estabilidad. El lacado de la base metálica es transparente como acabado estándar. The Konus Oval table features an inverted conical base with a circular wooden bottom trim and an oval steel metal base that provides stability. The lacquer of the metal base is transparent as a standard finish.



Detalle del acabado de listones de madera de fresno con forma de remo. Detail of the finish of oar-shaped ash wood slats.





KONUS

Konus Single Cuadrada C2 140x140
Top Dekton Kelya+Bisel Fibracolor
Pie MF66 Olmo

Oslo Chair
Asiento MY131 - MF66 Olmo



■ KONUS

El formato de encimera cuadrada C2 se presenta con un radio de 10cm en las esquinas
 The C2 square countertop format comes with a radius of 10cm in the corners



Detalle del acabado de listones de madera de fresno con forma de remo.
 Detail of the finish of oar-shaped ash wood slats.

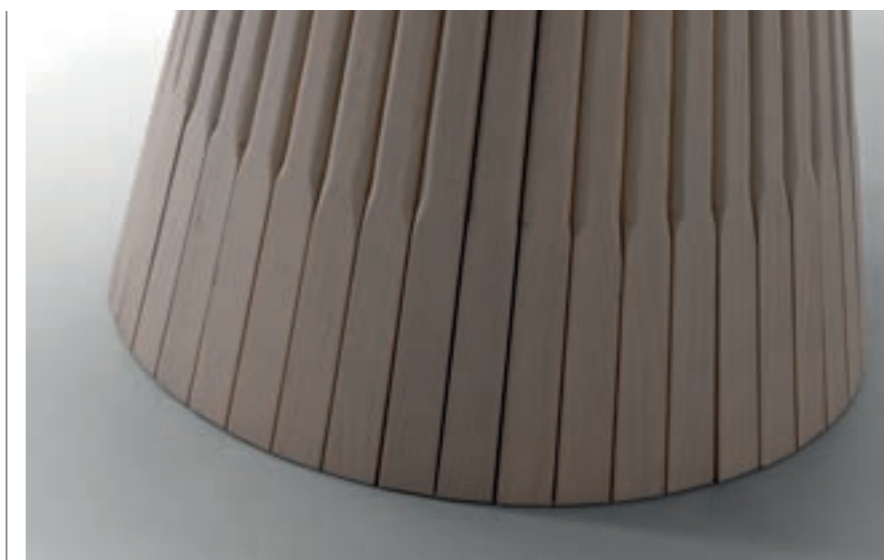



Konus Single Redonda R - 120cm
Top Dekton Rem. Base MF52 Grigio

Galán Armchair Asiento MA00. Estructura MF52 Grigio



- 1 ES. La encimera se puede pedir en 5 materiales diferentes: (DK) Dekton®, (CE) Cerámica, (CA) Cristal Mate Anti-Rayas, (FE)Fenix® y (MF)Madera de Fresno. Para cada material hay distintos colores que permiten hacer todo tipo de combinaciones.
EN. The top is available in 5 different materials: (DK) Dekton®, (CE) Ceramic, (CA)Matt Scratch-Resistant Glass, (FE)Fenix®, or (MF) Ashwood. There is a wide range of colour combinations for all of the materials.
- 2 ES. La base de la encimera se puede pedir en dos opciones: fibracolor negro biselado o tablero marino biselado a juego con el pie de la mesa.
EN. The base of the countertop can be ordered in two options: beveled black core MDF or beveled marine board to match with the color of the leg of the table.
- 3 ES. Las patas de la mesa están hechas de listones de madera maciza de fresno.
EN. The table legs are made of solid ash wood slats.

KONUS

Konus se presenta con 4 formas de encimera: redonda, cuadrada, ovalada y rectangular. Cada una de ellas con gran variedad de medidas y materiales. Además, dependiendo del formato, el pie Konus se puede utilizar en posición invertida y para formatos de gran tamaño la mesa puede necesitar dos pies.

Model Knows comes with 4 countertop shapes: round, square, oval and rectangular. Each of them with a wide variety of measurements and materials. Also, depending on the format, the Konus leg can be used in an inverted position and for large sizes the table may need two feet.

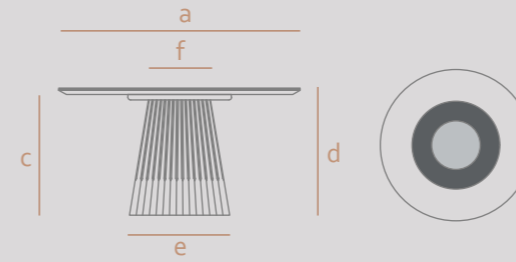

Single, Redonda (R)
Single, Round (R)

a	c	d	e	f	👤
100	73	76	58	32	5
110	73	76	58	32	5
120	73	76	58	32	6
130	73	76	58	32	7
140	73	76	58	32	7

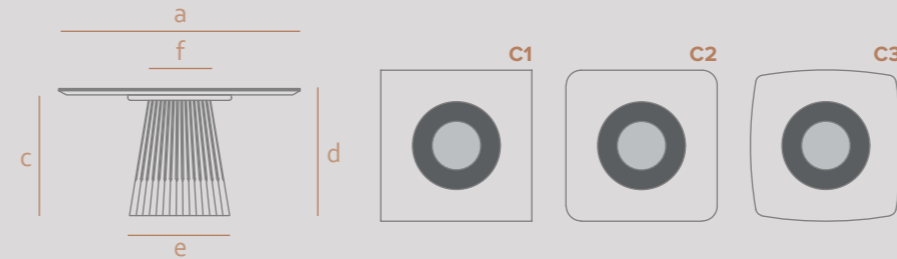

Single, Cuadrada en 3 opciones (C1, C2, C3)
Single, Square in 3 options (C1, C2, C3)

a	b	c	d	e	f	👤
125	125	73	76	58	32	4
140	140	73	76	58	32	8

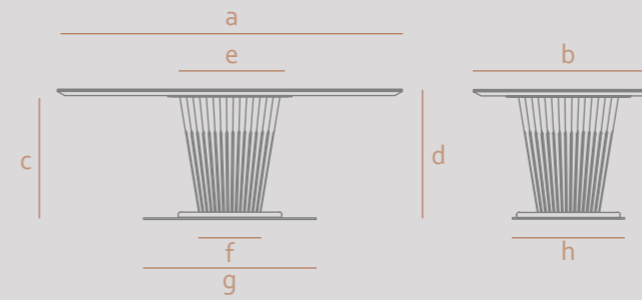

Inverted, Oval (V3) ó Rectangular con dos formatos diferentes (V1, V2)
Inverted, Oval (V3) or Rectangular with two different formats (V1, V2)

a	b	c	d	e	f	g	h	👤
200	100	74	78	100	32	100	65	8
240	105	74	78	100	32	100	70	10

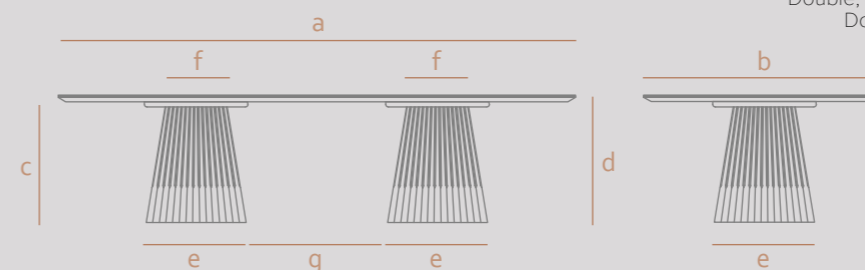

Double, Ovalada (D3) ó Rectangular con dos formatos diferentes (D1, D2)
Double, Oval (D3) or Rectangular with two different formats (D1, D2)

a	b	c	d	e	f	g	👤
260	105	73	77	58	32	42	10
300	120	73	77	58	32	82	12



Pippa es una mesa ligera y robusta al mismo tiempo, con un diseño contemporáneo sutilmente industrial. El pie de la mesa está formado por dos aros metálicos perfectamente unidos por tubos rectangulares. El minimalismo de su diseño llama la atención por su simetría y la limpieza en sus uniones, perfectamente encajadas como las piezas de un reloj suizo.

PIPPA



Pippa is a light and robust table at the same time, with a subtly industrial contemporary design. The leg of the table is made up of two metal rings perfectly joined by rectangular tubes. The minimalism of its design draws attention for its symmetry and cleanliness in its joints, perfectly fitted like the parts of a swiss watch.



El concepto central de la mesa Pippa es la búsqueda de la versatilidad a través del diseño. El programa tiene 3 versiones: Single, Inverted y Double. Dentro de cada versión existen varias opciones de formas y múltiples combinaciones de materiales y acabados. Pippa es un mueble perfecto tanto para el Hogar como para cualquier estancia en el mundo del Contract. Además Tabou ofrece la opción de adaptar el modelo Pippa para uso exterior.

The main concept of the Pippa table is the search for versatility through design. The program has 3 versions: Single, Inverted and Double. Within each version there are several shape options and multiple combinations of materials and finishes. Pippa is a perfect piece of furniture both for the Home and for any room in the Contract world. Tabou also offers the option of adapting the Pippa model for outdoor use.

Single, Redonda (R) ó Cuadrada en 3 opciones (C1, C2, C3)
Single, Round (R) or Square in 3 options (C1, C2, C3)



Inverted, Oval (V3) ó Rectangular con dos formatos diferentes (V1, V2)
Inverted, Oval (V3) or Rectangular with two different formats (V1, V2)



Double, Ovalada (D3) ó Rectangular con dos formatos diferentes (D1, D2)
Double, Oval (D3) or Rectangular with two different formats (D1, D2)





■ PIPPA

Pippa Double Rectangular D1 - 300x120
Top Inalco Black Prugna. Base ME03 Negro

Logan W Chair
Asiento MY250. Patas LT03 Negro



PIPPA

La perfección de las formas y proporciones es fundamental para conseguir un buen diseño. Desde cualquier punto de vista la mesa Pippa transmite tanta ligereza y transparencia a través de los espacios de sus ventanas como fortaleza constructiva. Perfection of shapes and proportions is essential to achieve a good design. From any point of view, Pippa transmits as much lightness and transparency through its window spaces as a constructive strength.



El minimalismo sólo funciona cuando los acabados son perfectos y se logra un diseño pulcro que parece simple pero esconde pequeños detalles que marcan una gran diferencia. Minimalism only works when the finishes are perfect and a neat design is achieved that seems simple but hides small details that make a big difference.





Pippa Single Redonda R. 120cm
Top Dekton Rem. Base ME03 Negro

Galán Met Armchair
Asiento MY50. Estructura ME03 Negro



PIPPA

- 1 ES. La encimera se puede pedir en 6 materiales diferentes: (DK) Dekton®, (CE) Cerámica, (CA) Cristal Mate Anti- Rayas, (FE)Fenix®, (MF)Madera de Fresno y (MR) Madera de Roble. Para cada material hay distintos colores que permiten hacer todo tipo de combinaciones.
EN. The top is available in 6 different materials: (DK) Dekton®, (CE) Ceramic, (CA)Matt Scratch-Resistant Glass, (FE)Fenix®, (MF) Ashwood, or (MR) Oakwood.
There is a wide range of colour combinations for all of the materials.
- 2 ES. La base de la encimera se puede pedir en dos opciones: fibracolor negro biselado o tablero marino biselado a juego con el pie de la mesa.
EN. The base of the countertop can be ordered in two options: beveled black core MDF or beveled marine board to match with the color of the leg of the table.
- 3 ES. El pie de la mesa está hecho de tubos de acero soldados sobre una peana de acero macizo. Disponible en cualquier color epoxy de nuestra carta.
EN. The base of the table is made of steel tubes welded onto a solid steel base. Available in any epoxy color from our menu.

Pippa se presenta con 4 formas de encimera: redonda, cuadrada, ovalada y rectangular. Cada una de ellas con gran variedad de medidas y materiales. Dependiendo del formato, el pie Pippa se puede utilizar en posición invertida y para formatos de gran tamaño la mesa puede necesitar dos pies. Pippa está disponible en medidas especiales y en versión exterior.

Pippa comes in 4 countertop shapes: round, square, oval and rectangular. Each of them with a wide variety of measurements and materials. Depending on the format, the Pippa foot can be used in an inverted position and for large formats the table may need two legs. Pippa is available in special sizes and in an outdoor version.



Single, Redonda (R)
Single, Round (R)

a	c	d	e	f	👤
100	73	76	65	40	5
110	73	76	65	40	5
120	73	76	65	40	6
130	73	76	65	40	7
140	73	76	65	40	7

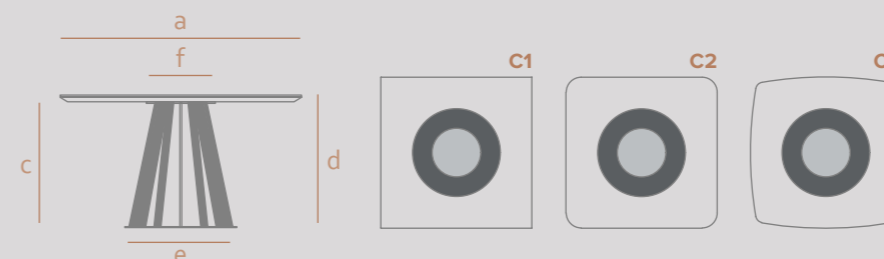

Single, Cuadrada en 3 opciones (C1, C2, C3)
Single, Square in 3 options (C1, C2, C3)

a	b	c	d	e	f	👤
125	125	73	76	65	40	4
140	140	73	76	65	40	8

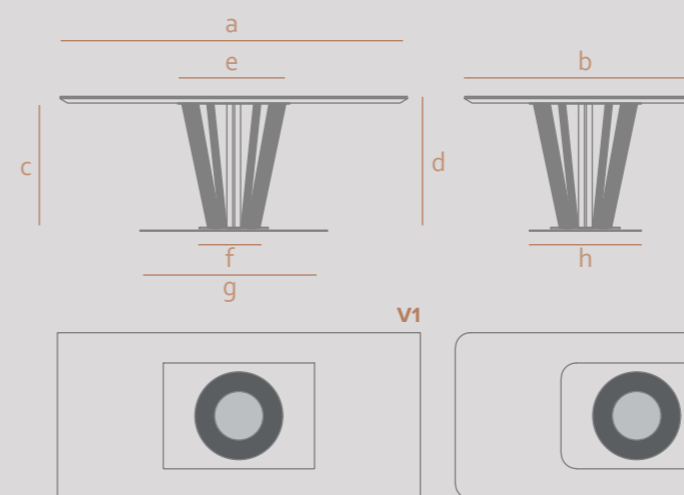

Inverted, Oval (V3) ó Rectangular con dos formatos diferentes (V1, V2)
Inverted, Oval (V3) or Rectangular with two different formats (V1, V2)

a	b	c	d	e	f	g	h	👤
200	100	73	78	65	40	100	65	8
240	105	73	78	65	40	100	70	10

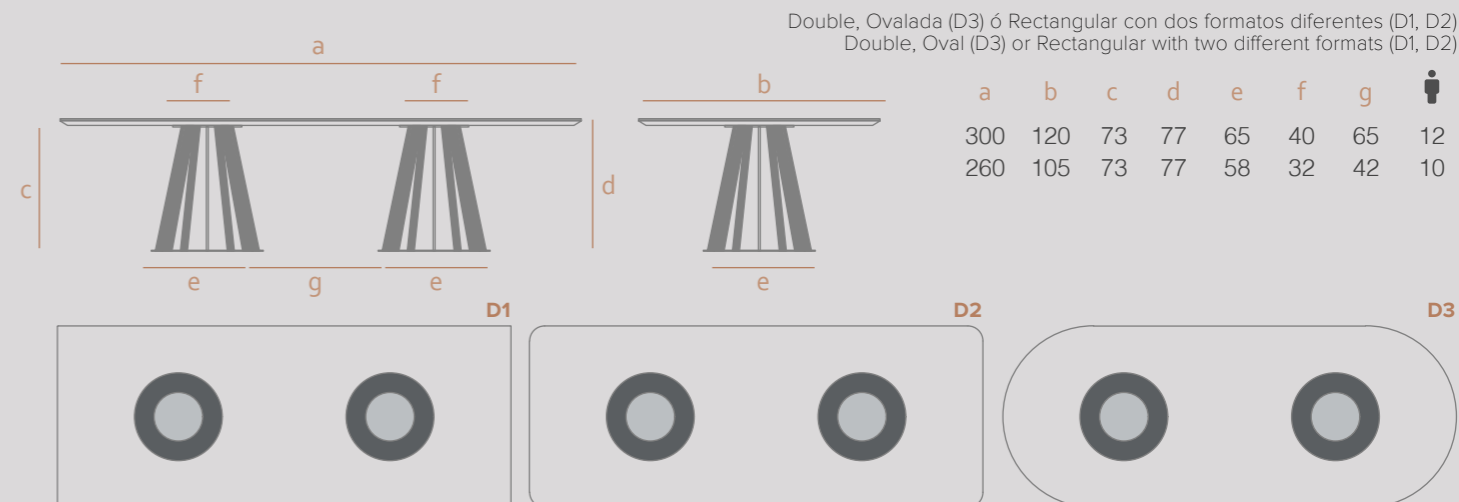

Double, Ovalada (D3) ó Rectangular con dos formatos diferentes (D1, D2)
Double, Oval (D3) or Rectangular with two different formats (D1, D2)

a	b	c	d	e	f	g	👤
300	120	73	77	65	40	65	12
260	105	73	77	58	32	42	10

Havana es sencillez, elegancia y versatilidad. Se trata de una mesa con un diseño práctico y muy decorativo que enriquece cualquier ambiente de una forma sutil y sofisticada. El pie de la mesa tiene dos versiones para poder adaptarse a la forma y tamaño elegidos para respetar las proporciones de forma armoniosa.



Havana means simplicity, elegance and versatility. It is a table with a practical and highly decorative design that enriches any environment in a subtle and sophisticated way. The leg design has two versions to adapt it to the shape and size chosen to respect the proportions in a harmonious way.

HAVANA

El concepto central de la mesa Havana es la búsqueda de la versatilidad sin perder la elegancia en ningún momento. El programa tiene 4 versiones: Single Redonda Small, Single Redonda Big, Single Cuadrada y Double. Dentro de cada versión existen varias opciones de formas y múltiples combinaciones de materiales y acabados. El pie de la mesa Havana se monta con la combinación específica diseñada para cada uno de sus formatos. Havana es un mueble perfecto tanto para el hogar como para cualquier estancia en el mundo del Contract. Además Tabou ofrece la opción de adaptar el modelo Havana para uso exterior.

The main concept of the Havana table is the search for versatility without losing elegance at any time. The program has 4 versions: Single Round Small, Single Round Big, Single Square and Double. Within each version there are several shape options and multiple combinations of materials and finishes. The foot of the Havana table is assembled with the specific combination designed for each of its formats. Havana is a perfect piece of furniture both for the home and for any room in the world of Contract. Tabou also offers the option of adapting the Havana model for outdoor use.

Single Redonda Small (RS) para diámetro 100 y 110cm
Single Round Small (RS) for diameter 100 and 110cm



Single Redonda Big (RB) para diámetro 120, 130 y 140cm
Single Round Big (RB) for diameter 120, 130 and 140cm



Single Cuadrada, con tres formas diferentes (C1, C2 y C3)
Single Square, with three different shapes (C1, C2 and C3)



Double, Oval (D3) ó Rectangular con dos formatos diferentes (D1, D2).
Double, Oval (D3) or Rectangular with two different formats (D1, D2).





HAVANA

Havana Oval D3 - 240x105
Top Neolith Amazonic . Base Oro Mate

Carmen Chair
Asiento Libra 51. Patas Oro Mate





HAVANA

Havana Redonda Big RB - 130cm
Top Madera Fresno 65 Nocciola. Base ME03 Negro

Logan Met Armchair
Asiento Libra 23. Estructura ME03 Negro



Single Redonda Small (RS) para diámetro 100 y 110cm
Single Round Small (RS) for diameter 100 and 110cm

a	c	d	e	f	👤
100	73	76	45	53	5
110	73	76	45	53	5

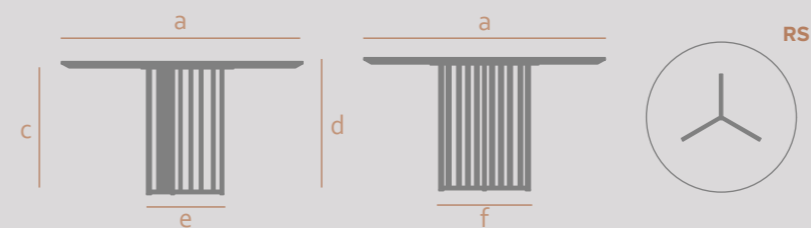

Single Redonda Big (RB) para diámetro 120, 130 y 140cm
Single Round Big (RB) for diameter 120, 130 and 140cm

a	c	d	e	f	👤
120	73	76	59	53	6
130	73	76	59	53	7
140	73	76	59	53	7

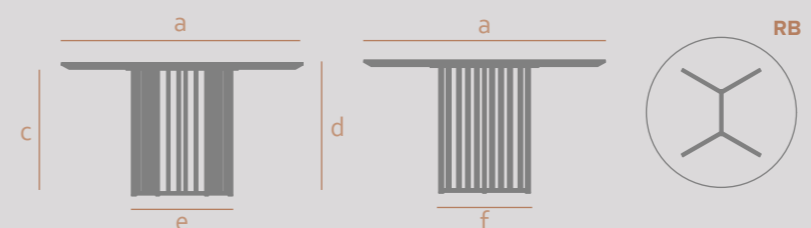

Single Cuadrada, con tres formas diferentes (C1, C2 y C3)
Single Square, with three different shapes (C1, C2 and C3)

a	b	c	d	e	f	👤
125	125	73	76	59	53	4
140	140	73	76	59	53	8

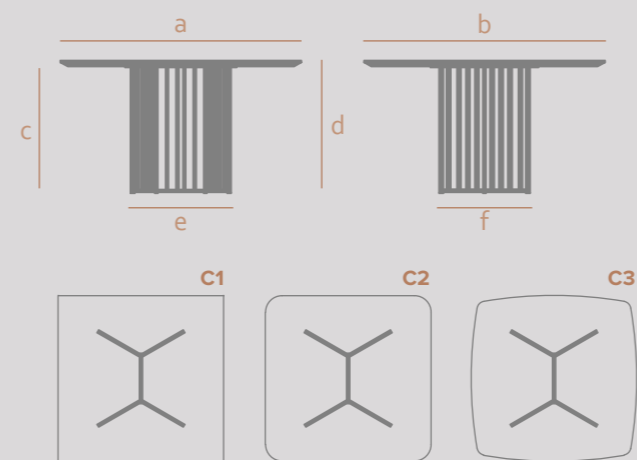

Double, Oval (D3) ó Rectangular con dos formatos diferentes (D1, D2).
Double, Oval (D3) or Rectangular with two different formats (D1, D2).

a	b	c	d	e	f	g	👤
200	100	73	77	45	53	21	8
240	105	73	77	45	53	51	10
300	120	73	77	45	53	111	12

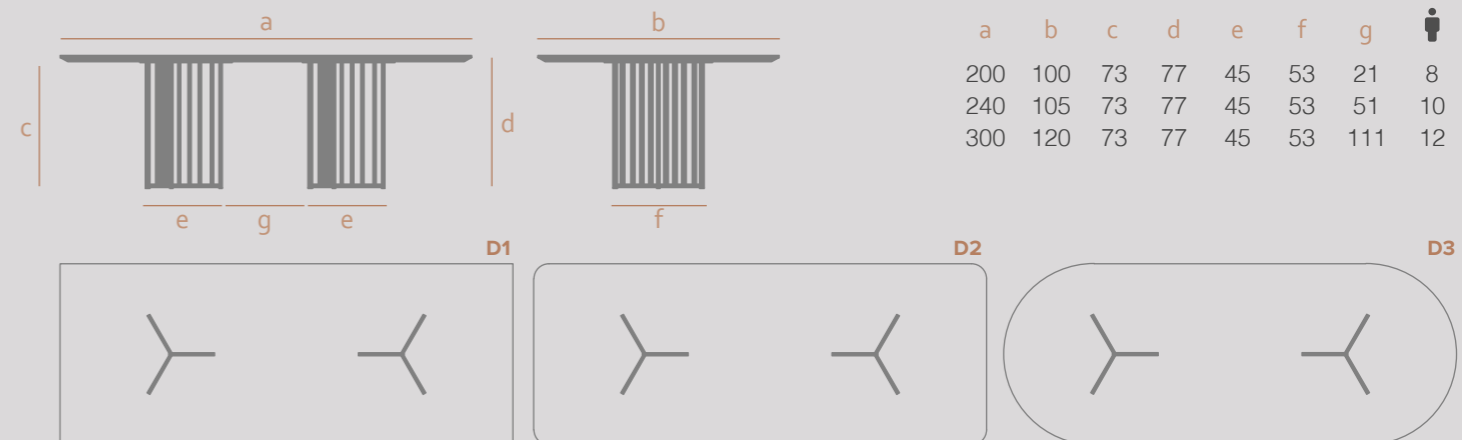

HAVANA



- 1 ES. La encimera se puede pedir en 6 materiales diferentes: (DK) Dekton®, (CE) Cerámica, (CA) Cristal Mate Anti-Rayas, (FE)Fenix®, (MF)Madera de Fresno y (MR) Madera de Roble. Para cada material hay distintos colores que permiten hacer todo tipo de combinaciones.
EN. The top is available in 5 different materials: (DK) Dekton®, (CE) Ceramic, (CA)Matt Scratch-Resistant Glass, (FE)Fenix®, (MF) Ashwood, or (MR) Oakwood. There is a wide range of colour combinations for all of the materials.
- 2 ES. La base de la encimera se puede pedir en dos opciones: fibracolor negro biselado o tablero marino biselado a juego con el pie de la mesa.
EN. The base of the countertop can be ordered in two options: beveled black core MDF or beveled marine board to match with the color of the leg of the table.
- 3 ES. El pie de la mesa está hecho de tubos de acero de 20x20mm. Disponible en cualquier color epoxy de nuestra carta.
EN. The base of the table is made of square steel tubes 20x20mm. Available in any epoxy color from our menu.

Morgan parece una mesa muy simple, pero sólo se puede conseguir el equilibrio necesario refinando el menor de los detalles. Las pequeñas cosas son fundamentales cuando se quiere alcanzar la perfección.

MORGAN



Morgan seems like a very simple table, but the necessary balance can only be achieved by refining the smallest of details. The little things are essential when you want to achieve perfection.



Morgan es una mesa diferente por sus acabados exclusivos para la encimera: Compacto Fenix y Compacto Ker. Largos desde 125cm hasta 210cm. Anchos desde 80cm hasta 100cm. Componentes metálicos en 10 colores. Pata en madera de fresno con 7 tintes o laca a poro abierto en los mismos colores del metal.

Morgan is a different table due to its exclusive finishes for the countertop: Compact Fenix and Compact Ker. Lengths from 125cm to 210cm. Widths from 80cm to 100cm. Metal components in 10 colors. Leg in ash wood with 7 stains or open pore lacquer in the same colors as the metal.

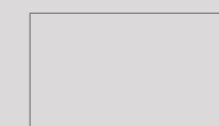

125x80	140x100
125x90	165x100
140x90	190x100
165x90	210x100
190x90	
210x90	



MORGAN

Morgan 180x100 Extensible
Top Compac Fenix Negro. Metal 03 Negro. Fresno 65 Nocciola
Ponte Chair
Asiento Libra11. Metal 03 Negro



Morgan 180x100 Extensible
Top Compac Fenix Negro. Metal 03 Negro. Fresno 65 Nocciola

Ponte Chair
Asiento Libra11. Metal 03 Negro



Unión entre la pata, el bastidor y la encimera
Union between the leg, the frame and the countertop



Imagen del diseño de la pata
Image of leg design





2 Extensiones / 2 Extensions / 2 Extensions / 2 Ausziehplatte



axb	c	d	e	f	g	h	📏	👤	👥
125x80	75	115	70	165-205	155-195	68	2	6	8
125x90	75	115	80	165-205	155-195	68	2	6	8
140x90	75	130	80	190-240	180-230	68	2	6	10
165x90	75	155	80	215-265	205-255	68	2	8	10
190x90	75	180	80	240-290	230-280	68	2	8	12
210x90	75	200	80	260-310	250-300	68	2	10	12
140x100	75	130	90	190-240	180-230	68	2	6	10
165x100	75	155	90	215-265	205-255	68	2	8	10
190x100	75	180	90	240-290	230-280	68	2	8	12
210x100	75	200	90	260-310	250-300	68	2	10	12

MORGAN

- 1 ES. Encimera Compacto 10mm.
EN. The top Compact Top10mm.
- 2 ES. Guías de aluminio.
EN. Aluminium guides.
- 3 ES. Bastidor metálico.
EN. Metal Frame.
- 4 ES. Patas de madera de fresno.
EN. Solid Ashwood legs.

Acabados disponibles para la encimera:
Available finishes for tops:

Compacto Fenix 10mm®

Acabado exclusivo para el modelo Morgan de este laminado compacto de alta presión de tacto sedoso super-mate, anti-huellas y auto-reparable térmicamente. Exclusive finish for the Morgan model of this compact high-pressure laminate with a super-matte silky touch, anti-fingerprint and thermally self-healing.

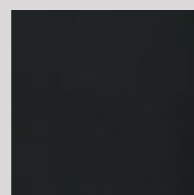

0720 NEGRO INGO

Compacto Ker 10mm®

Acabado exclusivo para el modelo Morgan de este laminado compacto de alta presión de diseño marmoleado negro con una suave veta blanquecina y el núcleo del mismo tono. Exclusive finish for the Morgan model of this compact high-pressure laminate with a black marble design with a soft whitish grain and the core of the same tone.

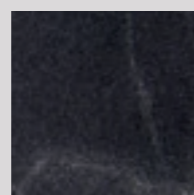

BLACK KANDIA

Morgan es una mesa donde la sutileza y el minimalismo encuentran su esencia. Por su diseño, la encimera se presenta en un único material, un compacto fenólico de 10mm que parece sostenerse sólo. Su estructura formada por guías de aluminio, piezas de acero y patas en madera maciza de fresno está perfectamente estudiada para ser fuerte y transmitir ligereza al mismo tiempo.

Morgan is a table where subtlety and minimalism find their essence. Due to its design, the countertop comes in a single material, a 10mm phenolic compact that seems to stand on its own. Its structure made up of aluminum guides, steel pieces and solid ash wood legs is perfectly designed to be strong and transmit lightness at the same time.

📏 Numero de extensiones
Number of extensions

👤 Plazas mesa cerrada
Closed table seating capacity

👥 Plazas mesa abierta
Open table seating capacity

📏 Sección de pata
Leg section: 50x50 mm

📏 Extensiones tipo libro
Butterfly leaf extensions

📏 Rodamientos en las patas para facilitar apertura
Bearings on legs for easy opening

🔒 Freno por fricción
Friction brake

📏 Nivelación extensible-encimera
Extension-worktop leveling

Nora es una mesa vanguardista y contemporánea. Por su diseño la superficie de la mesa parece flotar en el aire encima de las patas. Esa ligereza contrasta con la fortaleza de su estructura. Nora está disponible en una gran variedad de formatos y acabados. Incluso puede servir como mesa de exterior

NORA



Nora is an avant-garde and contemporary table. Due to its design, the table surface seems to float in the air above the legs. This lightness contrasts with the strength of its structure. Nora is available in a wide variety of formats and finishes. It can even serve as an outdoor table.



Nora se ofrece en formato rectangular o cuadrado, en versión fija o extensible y con una extensión de 70cm o dos extensiones de 50cm. Su amplio rango de medidas le permiten adaptarse cualquier espacio y la hacen una solución ideal ante la necesidad de una mesa de gran formato. Además presenta una amplia gama de acabados tanto para la encimera como para la estructura que permiten que la mesa se pueda personalizar con miles de combinaciones.

Nora is offered in rectangular or square format, in a fixed or extendable version and with a 70cm extension or two 50cm extensions. Its wide range of measurements allows it to adapt to any space and makes it an ideal solution for the need for a large format table. It also presents a wide assortment of finishes for both the countertop and the structure that allow the table to be customized with thousands of combinations.

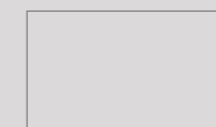

140x90
160x90
180x90
180x100
200x100
220x100
250x100
300x100
200x125
220x125
250x125
300x125

125x125
140x140



■ NORA

Nora Extensible 200x100 Extensible (270x100)
Top Dekton Laurent - Base Met03 Negro

Emma Chair
Brunei 02. Patas Met03 Negro



■ NORA

El ajuste de las distintas piezas encaja perfectamente de forma que la presencia de la mesa es compacta y con un alto nivel en la calidad de sus acabados.
The adjustment of the different pieces fits perfectly so that the presence of the table is compact and with a high level of quality in its finishes.



El aspecto de la mesa es de una gran armonía entre todos sus elementos. Es un diseño que permite que destaque tanto la encimera elegida como el cuerpo de la mesa gracias a la pureza de sus líneas.
The look of the table is of great harmony between all its elements. It is a design that allows both the chosen countertop and the body of the table to stand out thanks to the purity of its lines.





■ NORA

Nora Fija 200x100
Top Fenix 0720 Nero - Base Met03 Negro

Tamago GI Chair
Libra 11. Patas PU Antracita



Nora Fija 200x100
Top Fenix 0720 Nero - Base Met03 Negro

Tamago GI Chair
Libra 11. Patas PU Antracita

Detalle del la encimera aplacada sobre tablero en fibracolor negro biselado
Detail of the countertop veneered on a beveled black fiberboard



Imagen del aspecto ultramate y sedoso de la encimera en Fenix
Image of the ultra-matte and silky look of the countertop in Fenix





1 Extensión 70 cm / 1 Extension 70cm / 1 Allonge 70cm / 1 Auszieplatte 70cm



axb	c	d	e	f	g	h	i	📏	👤	👥
140x90	76	118	67	61	82	210	188	1	6	8
160x90	76	138	67	61	82	230	208	1	6	10
180x90	76	158	67	61	82	250	228	1	8	10
180x100	76	158	67	71	92	250	228	1	8	10
200x100	76	178	67	71	92	270	248	1	8	12
220x100	76	198	67	71	92	290	268	1	10	12
250x100	76	238	67	71	92	320	298	1	10	14
125x125	76	103	67	96	117	195	173	1	8	10
160x125	76	138	67	96	117	230	208	1	10	12
180x125	76	158	67	96	117	250	228	1	10	12
200x125	76	178	67	96	117	270	248	1	10	14
220x125	76	198	67	96	117	290	268	1	12	14
250x125	76	238	67	96	117	320	298	1	12	16
140x140	76	118	67	111	132	210	188	1	8	10

NORA

2 Extensiones 50cm / 2 Extensions 50cm / 2 Allonges 50cm / 2 Auszieplatte 50cm



axb	c	d	e	f	g	h	i	j	k	📏	👤	👥
140x90	76	118	67	61	82	190	168	240	218	2	6	10
160x90	76	138	67	61	82	210	188	260	238	2	6	10
180x90	76	158	67	61	82	230	208	280	258	2	8	12
180x100	76	158	67	71	92	230	208	280	258	2	8	12
200x100	76	178	67	71	92	250	228	300	278	2	8	12
220x100	76	198	67	71	92	270	248	320	298	2	10	14
250x100	76	238	67	71	92	300	278	350	328	2	10	14
125x125	76	103	67	96	117	175	153	225	203	2	8	12
160x125	76	138	67	96	117	210	188	260	238	2	10	14
180x125	76	158	67	96	117	230	208	280	258	2	10	14
200x125	76	178	67	96	117	250	228	300	278	2	10	14
220x125	76	198	67	96	117	270	248	320	298	2	12	16
250x125	76	238	67	96	117	300	278	350	328	2	12	16
140x140	76	118	67	111	132	190	168	240	218	2	8	12

- 1 ES. La encimera se puede pedir en 6 materiales diferentes: (DK) Dekton®, (CE) Cerámica, (CA) Cristal Mate Anti-Rayas, (FE)Fenix®, (MF)Madera de Fresno y (MR) Madera de Roble. Para cada material hay distintos colores que permiten hacer todo tipo de combinaciones.
EN. The top is available in 6 different materials: (DK) Dekton®, (CE) Ceramic, (CA)Matt Scratch-Resistant Glass, (FE)Fenix®, (MF) Ashwood, or (MR) Oakwood.
There is a wide range of colour combinations for all of the materials.
- 2 ES. La base de la encimera se puede pedir en dos opciones: fibracolor negro biselado o tablero marino biselado tintado o lacado a juego con el pie de la mesa.
EN. The base of the countertop can be ordered in two options: beveled black MDF or stained / lacquered beveled marine board to match the leg of the table.
- 3 ES. Las guías de extensión de la mesa son de aluminio lacado.
EN. Opening table guides made from lacquered aluminum.
- 4 ES. Las patas y el resto de elementos embellecedores son de acero lacado.
EN. The legs and the rest of the decorative elements are made of lacquered steel.

El diseño atemporal de Nora y su amplio rango de medidas y acabados de serie le permiten adaptarse a cualquier espacio sin perder en ningún momento su elegancia y proporciones.

Nora's timeless design and its wide range of sizes and standard finishes allow it to adapt to any space without ever losing its elegance and proportions.

📏 Numero de extensiones
Number of extensions

👤 Plazas mesa cerrada
Closed table seating capacity

👥 Plazas mesa abierta
Open table seating capacity

📏 Sección de pata
Leg section: 50x50 mm

📏 Extensiones tipo libro
Butterfly leaf extensions

📏 Rodamientos en las patas para facilitar apertura
Bearings on legs for easy opening

🔒 Freno por fricción
Friction brake

📏 Nivelación extensible-encimera
Extension-worktop leveling

Nomad es una mesa contemporánea y minimalista. Sus proporciones y la pureza de sus líneas se combinan perfectamente en un diseño que sólo puede mostrar su esplendor en madera maciza. Diseñada con una proporción visual muy equilibrada que destila elegancia y fortaleza al mismo tiempo, Nomad su personalidad es inconfundible.

NOMAD



Nomad is a contemporary and minimalist table. Its proportions and the purity of its lines are perfectly combined in a design that can only show its beauty through solid wood. Designed with a very balanced visual proportion that exudes elegance and strength at the same time, Nomad has its unmistakable personality.



La base de Nomad está hecha en madera de Fresno con una amplia carta de acabados en tintes y lacas a poro abierto. El material de la encimera puede elegirse entre una gran variedad de acabados cerámicos, cristales y maderas. Formatos disponibles, fijas y extensibles:

The Nomad base is made of Ash wood with a wide range of finishes in stains and open-pore lacquers. The countertop material can be chosen from a wide variety of ceramic, glass and wood finishes. Available formats, fixed and extensible:



140x90
160x90
180x90
200x100
220x100
250x100
300x100
250x125

125x125
140x140



NOMAD

Nomad 180x90cm Exten. 230/280x90cm
Top Dekton 8mm Entzo. Base Fresno/Ash MF11 Nogal Claro

Nomad chair
Asiento MY01. Base Fresno/Ash MF11 Nogal Claro

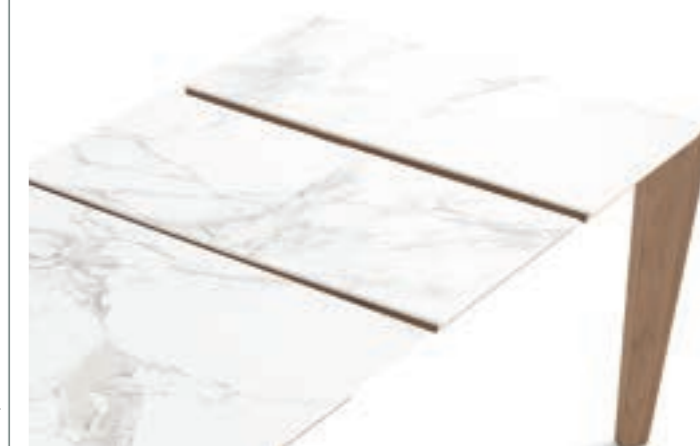

Existe la opción de pedir la mesa con 1 extensión de 70cm o 2 extensiones de 50cm.
The table can be ordered with 1x70cm or 2x50cm extensions.



El sistema de apertura es por guías de aluminio en cualquier color de nuestra carta ME.
The extension system is by aluminum guides in any color of our ME chart.

NOMAD



Secuencia de apertura de la versión 180x90 con 2 extensiones individuales de 50cm

Opening sequence of the 180x90 version with 2 individual 50cm extensions

Mesa Nomad en formato Cuadrado 125x125cm con 1 extensible de 70cm.
 Tabou da la opción de elegir los mismos colores para distintos materiales.
 Esto permite que nuestras mesas y sillas puedan combinarse en acabado monocolor.

NOMAD



Nomad table in Square format 125x125cm with 1 70cm extension.
 Tabou offers the option of choosing the same colors for different materials.
 This allows our tables and chairs to be combined in a single color finish.



Nomad en formato cuadrado está disponible en dos medidas: 125x125 y 140x140cm.
 En su versión extensible la mesa puede abrir 1 extensión de 70cm o 2 extensiones de 50cm.
 Esto permite que prácticamente se pueda duplicar la superficie.

Nomad in square format is available in two sizes: 125x125 and 140x140cm.
 In its extendable version, the table can open 1 extension of 70cm or 2 extensions of 50cm.
 This allows the surface to be practically doubled.



■ **NOMAD**

Nomad 125x125cm Exten. 195x125cm
 Top Cristal Mate Anti-Rayas - CA102 Perla.
 Base Fresno lacado poro abierto - MFL102 Perla

Ximena GI chair
 Seat MY136 + Fresno/Ash MF50 Nordik
 Base GI Antracita.



NOMAD

1 Extensión / 1 Extension / 1 allonge / 1 Ausziehplatte

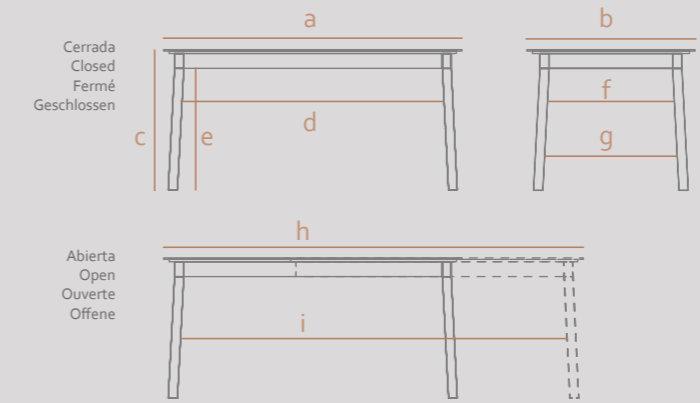

axb	c	d	e	f	g	h	i	☰	👤	👥
140x90	76	118	65	66	73	210	188	1	6	8
160x90	76	138	65	66	73	230	208	1	6	10
180x90	76	158	65	66	73	250	228	1	8	10
200x100	76	178	65	76	83	270	248	1	8	12
220x100	76	198	65	76	83	290	268	1	10	12
250x100	76	228	65	76	83	320	298	1	10	14
300x100	76	278	65	76	83	-	-	-	12	-
125x125	76	103	65	101	108	195	173	1	8	10
250x125	76	228	65	101	108	320	298	1	12	16
140x140	76	118	65	116	123	210	188	1	8	10

2 Extensiones / 2 Extensions / 2 Extensions / 2 Ausziehplatte

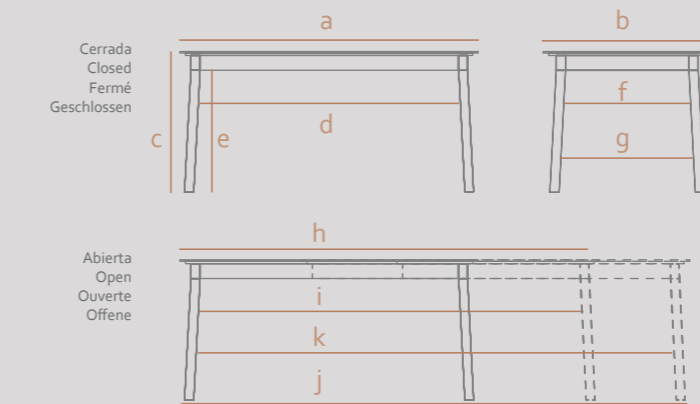

axb	c	d	e	f	g	h	i	j	k	☰	👤	👥
140x90	76	118	65	66	73	190	168	240	218	2	6	8
160x90	76	138	65	66	73	210	188	260	238	2	6	10
180x90	76	158	65	66	73	230	208	280	258	2	8	10
200x100	76	178	65	76	83	250	228	300	278	2	8	12
220x100	76	198	65	76	83	270	248	320	298	2	10	12
250x100	76	228	65	76	83	300	278	350	328	2	10	14
300x100	76	278	65	76	83	-	-	-	-	-	12	-
125x125	76	103	65	101	108	175	153	225	203	2	8	10
250x125	76	228	65	101	108	300	278	350	328	2	12	16
140x140	76	118	65	116	123	190	168	240	218	2	8	10

1 ES. La encimera se puede pedir en 5 materiales diferentes: (DK) Dekton®, (CE) Cerámica, (CA) Cristal Mate Anti-Rayas, (FE)Fenix® y (MF)Madera de Fresno.
 Para cada material hay distintos colores que permiten hacer todo tipo de combinaciones.
 EN. The top is available in 5 different materials: (DK) Dekton®, (CE) Ceramic, (CA)Matt Scratch-Resistant Glass, (FE)Fenix®, (MF) Ashwood, or (MR) Oakwood.
 There is a wide range of colour combinations for all of the materials.

2 ES. Las extensiones de la mesa son plegables y pueden ser del mismo material que la encimera de la mesa o de la misma madera que la base. Existe la opción de pedir la mesa con 1 o 2 extensiones. Las extensiones llevan un tirador integrado para facilitar el movimiento de apertura, reguladores para ajustar la planimetría de la mesa abierta y protecciones en las zonas de contacto.
 EN. The table extensions are foldable and can be made of the same material as the tabletop or the same wood as the base. There is the option to order the table with 1 or 2 extensions. The extensions have an integrated handle to facilitate the opening movement, regulators to adjust the flatness of the open table and protections in the contact areas.

3 ES. El sistema de apertura es por guías de aluminio de doble o triple cuerpo en función de la medida de la mesa.
 EN. The opening system is by double or triple body aluminum guides depending on the size of the table.

4 ES. La estructura de la mesa está hecha de madera maciza de Fresno.
 EN. The structure of the table is made of solid ashwood.

El diseño atemporal de Nomad y su amplio rango de medidas y acabados de serie le permiten adaptarse a cualquier espacio sin perder en ningún momento su elegancia y proporciones.

Nomad's timeless design and its wide range of sizes and standard finishes allow it to adapt to any space without ever losing its elegance and proportions.

☰ Numero de extensiones
Number of extensions

👤 Plazas mesa cerrada
Closed table seating capacity

👥 Plazas mesa abierta
Open table seating capacity

📏 Sección de pata
Leg section: 50x50 mm

☐ Extensiones tipo libro
Butterfly leaf extensions

📏 Apoyos con rodamiento bajo la encimera
Bearing supports under the worktop

🔒 Freno por fricción
Friction brake

⬆️ Nivelación extensible-encimera
Extension-worktop leveling

Kyoto es una mesa de comedor inspirada en las formas de las pagodas japonesas. Los ángulos que forman sus patas y su finas y armoniosas líneas constructivas le dan una original elegancia que recuerda la sutileza del diseño japonés.

KYOTO



Kyoto is a dining table inspired on the shapes of Japanese pagodas. The angles formed by its legs and its fine and harmonious construction lines give it an original elegance that recalls the subtlety of Japanese design.



Kyoto se ofrece en formato rectangular o cuadrado, en versión fija o extensible y con una extensión de 70cm o dos extensiones de 50cm. Su amplio rango de medidas le permiten adaptarse cualquier espacio y la hacen una solución ideal ante la necesidad de una mesa de gran formato. Además presenta una amplia gama de acabados tanto para la encimera como para la estructura que permiten que la mesa se pueda personalizar con miles de combinaciones.

Kyoto is offered in rectangular or square format, in a fixed or extendable version and with a 70cm extension or two 50cm extensions. Its wide range of measurements allows it to adapt to any space and makes it an ideal solution for the need for a large format table. It also presents a wide assortment of finishes for both the countertop and the structure that allow the table to be customized with thousands of combinations.

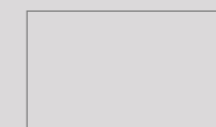

140x90
160x90
180x90
180x100
200x100
220x100
250x100
300x100
200x125
220x125
250x125
300x125

125x125
140x140



KYOTO

Kyoto Rectangular Extensible 250x125
Top Ascale Monteclema Silver. Base ME03 Negro

Kyoto Soft Chair
Asiento MY50. Patas LT03 Negro



■ KYOTO

El ajuste de las distintas piezas encaja perfectamente de forma que la presencia de la mesa es compacta y con un alto nivel en la calidad de sus acabados.
The adjustment of the different pieces fits perfectly so that the presence of the table is compact and with a high level of quality in its finishes.



El aspecto de la mesa es de una gran armonía entre todos sus elementos. Es un diseño que permite que destaque tanto la encimera elegida como el cuerpo de la mesa gracias a la pureza de sus líneas.
The look of the table is of great harmony between all its elements. It is a design that allows both the chosen countertop and the body of the table to stand out thanks to the purity of its lines.





Kyoto 180x90 extensible
Top Dekton Kelya. Base ME14 Grafito

Kyoto Chair
Asiento MY252. Estructura ME14 Grafit



El sistema de apertura es por guías de aluminio
Opening system for aluminum rails



Las extensiones de la mesa son plegables y del mismo material que la encimera de la mesa.
The foldable extension leaves are made of the same material as the table top.

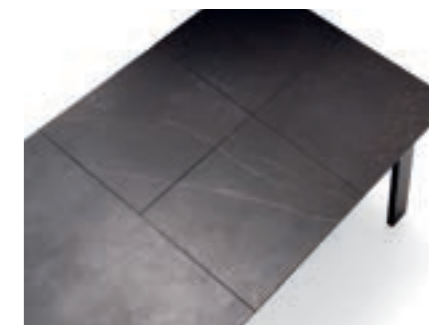

Existe la opción de pedir la mesa con 1 o 2 extensiones.
The table can be ordered with 1 or 2 extension leaves.



Detalle de la pieza lateral que une las dos patas dándole continuidad al diseño de la mesa
Detail of the side piece that joins the two legs giving continuity to the design of the table



La parte extensible tiene ruedas para facilitar el movimiento de apertura.
The extension leaves have runners on them to make it easier to pull them out.

■ KYOTO





1 Extensión 70 cm / 1 Extension 70cm / 1 Allonge 70cm / 1 Auszieplatte 70cm

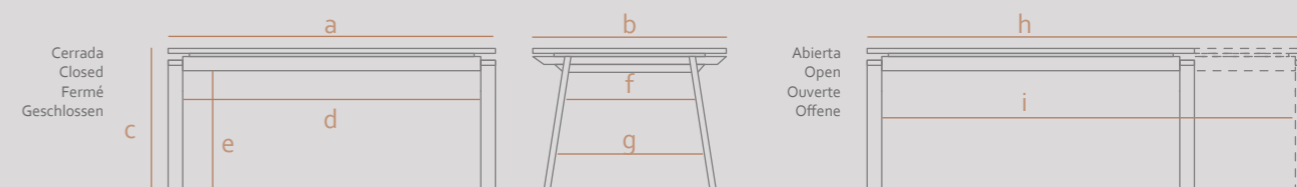

axb	c	d	e	f	g	h	i	📏	👤	👥
140x90	76	118	67	61	82	210	188	1	6	8
160x90	76	138	67	61	82	230	208	1	6	10
180x90	76	158	67	61	82	250	228	1	8	10
180x100	76	158	67	71	92	250	228	1	8	10
200x100	76	178	67	71	92	270	248	1	8	12
220x100	76	198	67	71	92	290	268	1	10	12
250x100	76	238	67	71	92	320	298	1	10	14
125x125	76	103	67	96	117	195	173	1	8	10
160x125	76	138	67	96	117	230	208	1	10	12
180x125	76	158	67	96	117	250	228	1	10	12
200x125	76	178	67	96	117	270	248	1	10	14
220x125	76	198	67	96	117	290	268	1	12	14
250x125	76	238	67	96	117	320	298	1	12	16
140x140	76	118	67	111	132	210	188	1	8	10

KYOTO

2 Extensiones 50cm / 2 Extensions 50cm / 2 Allonges 50cm / 2 Auszieplatte 50cm

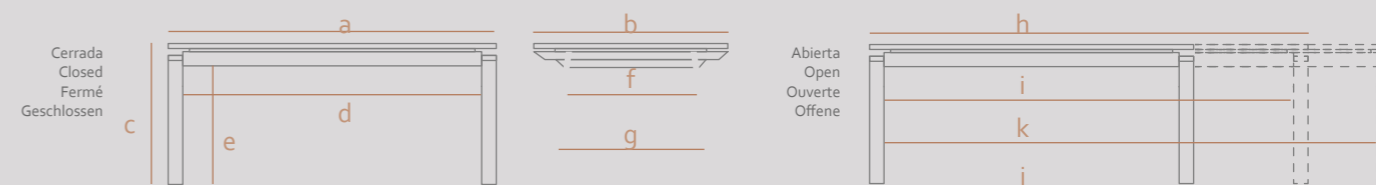

axb	c	d	e	f	g	h	i	j	k	📏	👤	👥
140x90	76	118	67	61	82	190	168	240	218	2	6	10
160x90	76	138	67	61	82	210	188	260	238	2	6	10
180x90	76	158	67	61	82	230	208	280	258	2	8	12
180x100	76	158	67	71	92	230	208	280	258	2	8	12
200x100	76	178	67	71	92	250	228	300	278	2	8	12
220x100	76	198	67	71	92	270	248	320	298	2	10	14
250x100	76	238	67	71	92	300	278	350	328	2	10	14
125x125	76	103	67	96	117	175	153	225	203	2	8	12
160x125	76	138	67	96	117	210	188	260	238	2	10	14
180x125	76	158	67	96	117	230	208	280	258	2	10	14
200x125	76	178	67	96	117	250	228	300	278	2	10	14
220x125	76	198	67	96	117	270	248	320	298	2	12	16
250x125	76	238	67	96	117	300	278	350	328	2	12	16
140x140	76	118	67	111	132	190	168	240	218	2	8	12

El diseño atemporal de Kyoto y su amplio rango de medidas y acabados de serie le permiten adaptarse a cualquier espacio sin perder en ningún momento su elegancia y proporciones.

kyoto's timeless design and its wide range of sizes and standard finishes allow it to adapt to any space without ever losing its elegance and proportions.

- ES. La encimera se puede pedir en 6 materiales diferentes: (DK) Dekton®, (CE) Cerámica, (CA) Cristal Mate Anti-Rayas, (FE)Fenix®, (MF)Madera de Fresno y (MR) Madera de Roble. Para cada material hay distintos colores que permiten hacer todo tipo de combinaciones.
EN. The top is available in 6 different materials: (DK) Dekton®, (CE) Ceramic, (CA)Matt Scratch-Resistant Glass, (FE)Fenix®, (MF) Ashwood, or (MR) Oakwood.
There is a wide range of colour combinations for all of the materials.
- ES. La base de la encimera se puede pedir en dos opciones: fibracolor negro biselado o tablero marino biselado tintado o lacado a juego con el pie de la mesa.
EN. The base of the countertop can be ordered in two options: beveled black MDF or stained / lacquered beveled marine board to match the leg of the table.
- ES. Las guías de extensión de la mesa son de aluminio lacado.
EN. Opening table guides made from lacquered aluminum.
- ES. Las patas y el resto de elementos embellecedores son de acero lacado.
EN. The legs and the rest of the decorative elements are made of lacquered steel.

📏 Numero de extensiones
Number of extensions

👤 Plazas mesa cerrada
Closed table seating capacity

👥 Plazas mesa abierta
Open table seating capacity

📏 Sección de pata
Leg section: 50x50 mm

📏 Extensiones tipo libro
Butterfly leaf extensions

📏 Rodamientos en las patas para facilitar apertura
Bearings on legs for easy opening

🔒 Freno por fricción
Friction brake

📏 Nivelación extensible-encimera
Extension-worktop leveling

Mikado es un diseño escultural y armonioso. Su pie central está formado por dos estructuras exactas que se cruzan buscando simetría y equilibrio al mismo tiempo. Desde cualquier punto de vista se contempla su equilibrio y la sutileza de sus líneas cruzándose sin tocarse para conseguir elegancia y perfección en su proporciones.

MIKADO





Mikado is a sculptural and harmonious design. Its central foot is formed by two exact structures that intersect seeking symmetry and balance at the same time. From any point of view, its balance and the subtlety of its lines can be seen, crossing without touching to achieve elegance and perfection in its proportions.



La estructura de acero de la mesa Mikado se puede lacar en un amplio rango de colores y su encimera, diseñada con apertura central sincronizada también dispone de una gran diversidad de materiales y acabados.

The steel structure of the Mikado table can be lacquered in a wide range of colors and its countertop, designed with a synchronized central opening, also has a wide variety of materials and finishes.

		
160x90 180x90 200x90	160x100 180x100 200x100 220x100 240x100	125x125 140x140 Ø125 Ø140



■ MIKADO

Mikado Redonda 125 Exten. 175x125cm
Top Dekton 8mm Aura. Base Metal ME03 Negro

Romeo GI armchair
Asiento ER35. Base Metal ME03 Negro



■ MIKADO





Mikado 180x90cm Exten. 230x90cm
Top Dekton Orix. Base Metal ME14 Grafito

Kyoto chair
Asiento BR2. Base Metal ME14 Grafito



12 apoyos con rodamiento para una suave apertura
12 supports with bearing for a smooth opening



Apertura Central Sincronizada
Synchronized Central Opening



Bloqueo del sistema de extensión
Blocking the extension system



Extensión de con base de madera barnizada, con asidero mecanizado y apoyo de seguridad.
Extension with varnished wood base, with mechanized handle and safety support.



Patas con reguladores de altura
Legs with height adjusters



Detalle de niveladores para las extensiones
Detail picture of levelers for extensions

■ MIKADO





MIKADO

1 Extensión / 1 Extension / 1 allonge / 1 Ausziehplatte

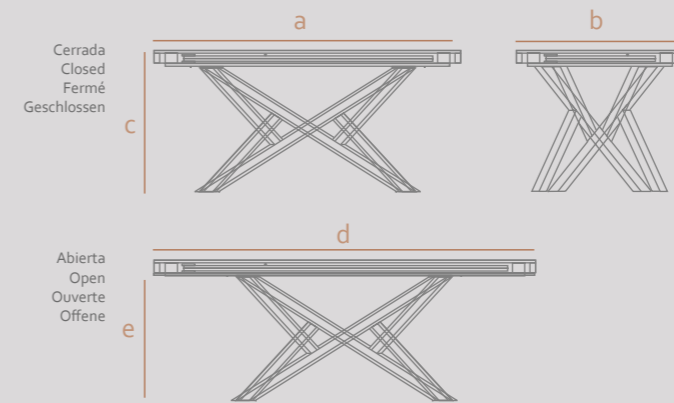

axb	c	d	e			
160x90	77	210	68	1	6	8
180x90	77	230	68	1	8	10
200x90	77	250	68	1	8	10
160x100	77	210	68	1	6	8
180x100	77	230	68	1	8	10
200x100	77	250	68	1	8	10
220x100	77	270	68	1	8	10
240x100	77	290	68	1	10	12
125x125	77	175	68	1	8	10
140x140	77	190	68	1	8	10
Ø 125	77	175	68	1	5	7
Ø 140	77	190	68	1	6	8

1 ES. La encimera se puede pedir en 6 materiales diferentes: (DK) Dekton®, (CE) Cerámica, (CA) Cristal Mate Anti-Rayas, (FE)Fenix®, (MF)Madera de Fresno y (MR) Madera de Roble. Para cada material hay distintos colores que permiten hacer todo tipo de combinaciones.
EN. The top is available in 5 different materials: (DK) Dekton®, (CE) Ceramic, (CA)Matt Scratch-Resistant Glass, (FE)Fenix®, (MF) Ashwood, or (MR) Oakwood.
There is a wide range of colour combinations for all of the materials.

2 ES. Las extensiones de la mesa son plegables y pueden ser del mismo material que la encimera de la mesa o de (LT) Madera Lacada en el mismo color de las patas. Las extensiones llevan un tirador integrado para facilitar el movimiento de apertura, reguladores para ajustar la planimetría de la mesa abierta y protecciones en las zonas de contacto. El sistema de extensión es por guías de cable con apertura sincronizada.
EN. The table extensions are foldable and can be made of the same material as the tabletop or made of (LT) Lacquered Wood in the same color of the legs. The extensions have an integrated handle to facilitate the opening movement, regulators to adjust the flatness of the open table and protections in the contact areas. The extension system is by cable guides with synchronized opening.

3 ES. La base de la encimera se puede pedir en dos opciones: fibracolor negro biselado o tablero marino biselado.
EN. The base of the countertop can be ordered in two options: beveled black core MDF or beveled marine board.

4 ES. Las patas de la mesa están hechas de tubo de acero de 50x50mm acabadas en (ME) epoxy termolacado.
EN. The table legs are made of 50x50mm steel tube finished in (ME) thermo-lacquered epoxy.

El modelo Mikado está disponible en 3 formatos: redonda, cuadrada y rectangular.

Materiales, colores y acabados disponibles en diferentes combinaciones realzan la personalidad de la mesa y permiten las más variadas soluciones.

Mikado model is available in 3 formats: round, square and rectangular.

Materials, colors and finishes available in different combinations enhance the personality of the table and allow the most varied solutions.

Numero de extensiones
Number of extensions

Plazas mesa cerrada
Closed table seating capacity

Plazas mesa abierta
Open table seating capacity

Sección de pata
Leg section: 50x50 mm

Extensiones tipo libro
Butterfly leaf extensions

Apoyos con rodamiento bajo la encimera
Bearing supports under the worktop

Freno por fricción
Friction brake

Nivelación extensible-encimera
Extension-worktop leveling



Es muy gratificante pensar que cada pieza que hacemos existe porque hay alguien que la quiere de verdad.

It is very gratifying to think that each piece we make exists because there is someone who really loves it.

Sillas
Chairs

GALÁN M



Pippa Single Redonda R. 120cm
Top Dekton Rem. Base ME03 Negro

Galán M Armchair
Asiento MY50. Estructura ME03 Negro



Materiales / Materials

	Asiento / Seat TP Tapizado / TP Upholstered
	Respaldo / Backrest TP Tapizado / TP Upholstered
	Estructura / Frame ME Metálica / ME Metal



GALÁN M
GALÁN W

Galán M Armchair
Asiento MY50. Estructura ME03 Negro

Galán W Armchair
Asiento MY144. Estructura MF52 Grigio

GALÁN W



Konus Single Redonda R - 120cm
Top Dekton Rem. Base MF52 Grigio

Galán W Armchair
Asiento MY50. Estructura MF52 Grigio



Materiales / Materials

	Asiento / Seat TP Tapizado / TP Upholstered
	Respaldo / Backrest TP Tapizado / TP Upholstered
	Estructura / Frame MF Madera Fresno / MF Ashwood

CARMEN



Carmen Chair
Asiento Libra 51. Patas ME03 Negro

Materiales / Materials

	Asiento / Seat TP Tapizado / TP Upholstered
	Respaldo / Backrest TP Tapizado / TP Upholstered
	Estructura / Frame ME Metálica / ME Metal

LOGAN M



Havana Redonda Big RB - 130cm
Top Madera Fresno 65 Nocciola. Base ME03 Negro

Logan M Armchair
Asiento Libra 23. Estructura ME03 Negro

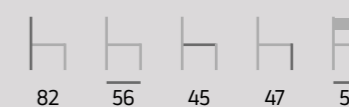

Materiales / Materials

	Asiento / Seat TP Tapizado / TP Upholstered
	Respaldo / Backrest TP Tapizado / TP Upholstered
	Estructura / Frame ME Metálica / ME Metal



■ LOGAN M
LOGAN W

Logan M Chair
Asiento Libra 23. Estructura ME03 Negro

Logan W Chair
Asiento Libra 23.Patas Fresno LT03 Negro

LOGAN W



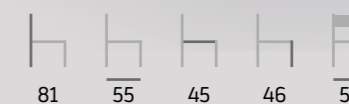

Pippa Double Rectangular D1 - 300x120
Top Inalco Black Prugna. Base ME03 Negro

Logan W Chair
Asiento MY250. Patas LT03 Negro



Materiales / Materials

	Asiento / Seat TP Tapizado / TP Upholstered
	Respaldo / Backrest TP Tapizado / TP Upholstered
	Estructura / Frame MF Madera Fresno / MF Ashwood



PONTE



Ponte Chair
Asiento LI11. Metal O3 Negro
Asiento MY510. Metal Oro Mate



Materiales / Materials

	Asiento / Seat TP Tapizado / TP Upholstered
	Respaldo / Backrest TP Tapizado / TP Upholstered
	Estructura / Frame ME Metálica / ME Metal

OSLO



Oslo Chair
Asiento MA6021. Estructura MH52 Grigio

Materiales / Materials

	Asiento / Seat TP Tapizado / TP Upholstered
	Estructura / Frame MF Madera Fresno / MF Ashwood



■ TAMAGO GI
 TAMAGO W
 TAMAGO 4P
 TAMAGO SL

La familia de sillones Tamago se presenta en 4 versiones:
 GI - Pie giratorio de poliuretano inyectado, color único en grafito
 W - Patas de madera de fresno barnizadas o lacadas
 4P - Patas metálicas de tubo redondo de 25mm
 SL - Patas de acero macizo de 10mm con forma de patín

The Tamago family of armchairs is available in 4 versions:
 GI - Injected polyurethane swivel foot, unique color Graphite
 W - Varnished or lacquered ash wood legs
 4P - 25mm round tube metal legs
 SL - 10mm solid steel skid-shaped legs



TAMAGO GI



Arqus 200x100 extensible.
Top Fenix Negro Bisel Fibracolor - Patas Met14 Grafito

Tamago GI
Asiento LI12 - Pie Giratorio Poliuretano Grafito

Materiales / Materials

	Asiento / Seat TP Tapizado / TP Upholstered
	Respaldo / Backrest TP Tapizado / TP Upholstered
	Estructura / Frame PI Poliuretano inyectado / PI Injected Poliurethane

TAMAGO SL



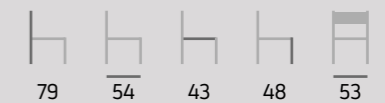

Karma 180x90 extensible.
Top Dekton Slim Laos. Base Met14 Grafito

Tamago SL
Asiento MY61 - Patas Met14 Grafito



Materiales / Materials

	Asiento / Seat TP Tapizado / TP Upholstered
	Respaldo / Backrest TP Tapizado / TP Upholstered
	Estructura / Frame ME Metálica / ME Metal

TAMAGO W





Mesa Mare Extensible - 180x90cm
Top FE30 Fenix Alaska. Base MH50 Nordik

Tamago W Armchair
Asiento MY32. Estructura MF50 Nordik



Materiales / Materials

	Asiento / Seat TP Tapizado / TP Upholstered
	Respaldo / Backrest TP Tapizado / TP Upholstered
	Estructura / Frame MF Madera de Fresno / MF Ashwood

TAMAGO 4P



Mesa Karma Extensible - 180x90cm
Top Dekton Bromo. Base ME03 Negro

Tamago 4P Armchair
Asiento MY214. Estructura ME03 Negro



Materiales / Materials

	Asiento / Seat TP Tapizado / TP Upholstered
	Respaldo / Backrest TP Tapizado / TP Upholstered
	Estructura / Frame ME Metálica / ME Metal

ROMEO GI





Mikado 125
Dekton Aura - Met03

Romeo
LI37 - Poliuretano Grafito



Materiales / Materials

	Asiento / Seat TP Tapizado / TP Upholstered
	Estructura / Frame PI Poliuretano inyectado / PI Injected Polyurethane

ROMEO TC



Materiales / Materials

	Asiento / Seat TP Tapizado / TP Upholstered
	Estructura / Frame ME Metal / ME Metal

KYOTO TC





Mikado 180x90
Dekton Orix - Met14

Kyoto
BR2 - Met14



Materiales / Materials

	Asiento / Seat TP Tapizado / TP Upholstered
	Respaldo / Backrest TP Tapizado / TP Upholstered
	Estructura / Frame ME Metálica / ME Metal

KYOTO PLUS TC



Kyoto 250x125
Ascale Monteclemo Silver - Met03

Kyoto Plus
TC Leather White - Met03



Materiales / Materials

	Asiento / Seat TP Tapizado / TP Upholstered
	Respaldo / Backrest TP Tapizado / TP Upholstered
	Estructura / Frame ME Metálica / ME Metal

NOMAD



Nomad 180x90cm Exten. 230/280x90cm
 Top Dekton 8mm Entzo
 Base Fresno/Ash MF11 Nogal Claro

Nomad chair
 Asiento MY01.
 Base Fresno/Ash MF11 Nogal Claro



Materiales / Materials

	Asiento / Seat TP Tapizado / TP Upholstered
	Respaldo / Backrest TP Tapizado / TP Upholstered
	Estructura / Frame MF Madera Fresno / MF Ashwood

EMMA





Nora 200x100
Top Dekton Laurent.
Base Met14 Grafito

Emma chair
Asiento BR02
Met14 Grafito



Materiales / Materials

	Asiento / Seat TP Tapizado / TP Upholstered
	Estructura / Frame ME Metal / ME Metal

XIMENA GI





Nomad 125x125
Cristal Mate Anti-Rayas CA102 - Fresno MFL102

Ximena GI
Asiento MY136 + Fresno MF50 - Base GI Antracita.



Materiales / Materials

	Asiento / Seat TP Tapizado / TP Upholstered MF Fresno / MF Ashwood
	Estructura / Frame PI Poliuretano inyectado / PI Injected Polyurethane

XIMENA TC



Materiales / Materials

	Asiento / Seat TP Tapizado / TP Upholstered MF Fresno / MF Ashwood
	Estructura / Frame ME Metal / ME Metal

La belleza de los detalles, colores y materiales es tan importante como la inteligencia a la hora de aplicarlos.

The beauty of the details, colors and materials is as important as intelligence when applying them.



Los materiales y sus colores.

The materials and their colors.

Dekton®
Cerámicos / Ceramics
Maderas / Woods
Fenix®
Cristal / Glass
Metal
Tapicerías / Fabrics

SUPERFICIES FUNCIONALES Y VERSÁTILES PARA MOBILIARIO

Cosentino® ofrece materiales únicos en una amplia gama de colores y texturas. Tanto Dekton® como Silestone® están disponibles en gran formato, ofreciendo infinitas posibilidades de diseño.

INNOVACIÓN APLICADA AL DISEÑO

Dekton® es una sofisticada mezcla de más de 20 minerales extraídos de la naturaleza. Su proceso productivo es el resultado de años de aprendizaje y la inspiración en la fabricación de vidrio, porcelánicos de última generación y superficies de composición mineral. La microscopía electrónica permite apreciar la reducida porosidad del material, consecuencia del proceso de sinterización y ultracompactación exclusiva de Dekton®. Esa reducida porosidad y la inexistencia de microdefectos causantes de tensiones o puntos débiles, constituyen la característica diferencial de Dekton®.

SELECCIÓN DEKTON® RECOMENDADA

Las mesas de Tabou Design están disponibles en todos los colores de Dekton®. Entre en www.dekton.com y vea la colección completa.



FUNCTIONAL AND VERSATILE SURFACES FOR FURNITURE

Cosentino® offers unique materials in a wide range of colors and textures. Both Dekton® and Silestone® are available in large formats, offering endless design possibilities.

INNOVATION APPLIED TO DESIGN

Dekton® is composed of a sophisticated blend of over 20 minerals extracted from nature. Its production process is the result of years of R&D in the manufacturing of glass, state-of-the-art porcelain, and quartz surfaces. Dekton® is created through an exclusive sintering process which creates an ultracompact slab with reduced porosity and the absence of micro-defects.

RECOMMENDED DEKTON® SELECTION

Tabou Design tables are available in all Dekton® colors. Visit www.dekton.com and see the complete collection

Aura	Laos
Avorio	Laurent
Grafite	Nebbia
Grigio	Rem
Kelya	Trilium

DEKTON®
Designed by COSENTINO



Dekton® Laurent

CE
CERÁMICO
CERAMIC

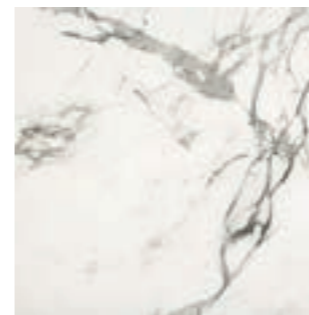

AURA
NATURAL COLLECTION
3

CAT. PRECIO /
PRICE CAT.



REM
NATURAL COLLECTION
3

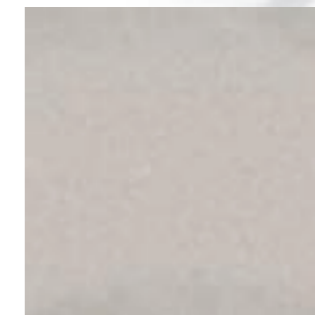

VK01 NEBBIA
PIETRA KODE COLLECTION
2

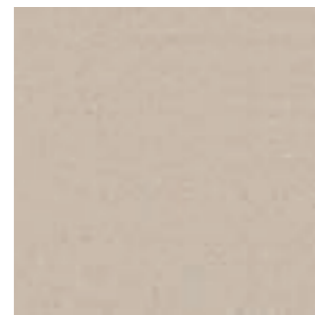

VK02 AVORIO
PIETRA KODE COLLECTION
2

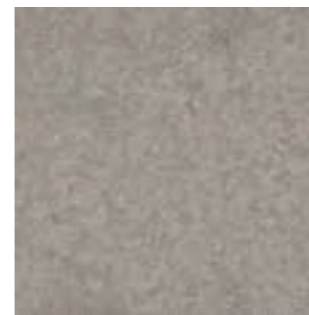

VK03 GRIGIO
PIETRA KODE COLLECTION
2

CAT. PRECIO /
PRICE CAT.

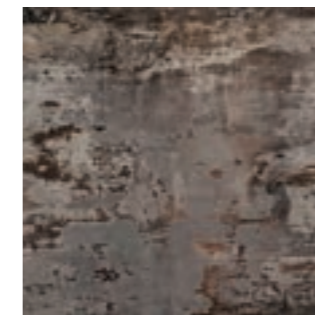

TRILIUM
INDUSTRIAL COLLECTION
2

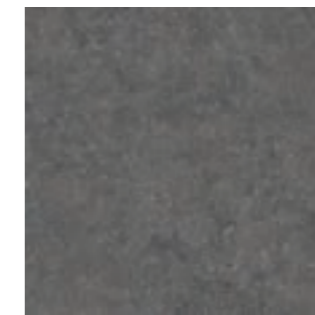

VK04 GRAFITE
PIETRA KODE COLLECTION
2

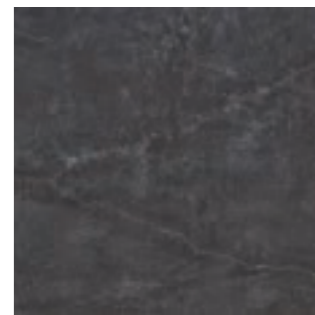

LAOS
INDUSTRIAL COLLECTION
2

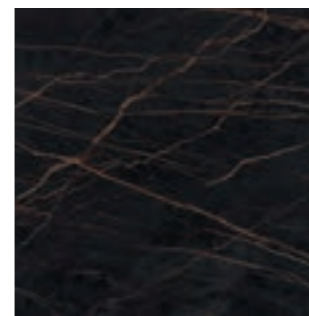

LAURENT
NATURAL COLLECTION
3

CAT. PRECIO /
PRICE CAT.

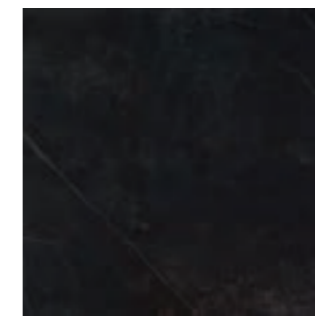

KELYA
NATURAL COLLECTION
2

Tabou Design fabrica sus mesas en cualquier acabado Dekton® y Silestone®. Solicite muestras si no dispone de ellas
Tabou Design manufactures its tables in any Dekton® or Silestone® finish. Request samples if you do not have them



CERÁMICA

Material perfecto para un uso doméstico intenso. Tiene una gran dureza, es impermeable, higiénico, de fácil limpieza y color inalterable. Es resistente al calor, al desgaste y es ecológico.

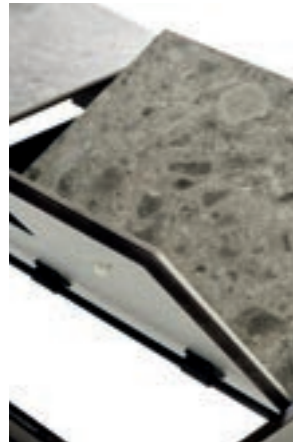

DETALLES DE FABRICACIÓN

Las encimeras de mesa cerámicas se fabrican en el formato de 6mm de espesor. El acabado perimetral de la placa de cerámica se presenta con los cantos pulidos, las aristas micro-biseladas y las esquinas redondeadas. La placa de cerámica siempre va pegada con adhesivos especiales sobre una base de seguridad. Esta base es un tablero que sirve de soporte de la cerámica aumentando la resistencia ante los golpes superficiales y ejerciendo como elemento de fijación de los mecanismos y el armazón de la mesa con la encimera. Cuando el canto del tablero de base queda a la vista, va acabado en coordinación con el resto de elementos de la mesa formando parte del diseño de la misma.

Encimera / Top

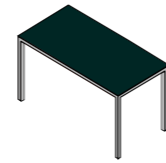

CERAMIC

Perfect material for intense domestic use. It has a great hardness, is waterproof, hygienic, easy to clean and unalterable in color. It is resistant to heat, wear and tear and is environmentally friendly.

MANUFACTURING DETAILS

The ceramic table tops are manufactured in the 6mm thick format. The perimeter finish of the ceramic table top is presented with polished micro-beveled edges and rounded corners. The ceramic plate is always glued with special adhesives on a security base. This base is a board that serves as a support for the ceramic, increasing the resistance to superficial blows and acting as a fixing element for the mechanisms and the frame of the table with the top surface. When the edge of the base board is visible, it is finished in coordination with the rest of elements of the table, forming part of its design.

CE - Cerámica - Colores Estándar / Ceramic - Standard Colors

Selección de colores muestrario Tabou / Selection of ceramic Tabou colors

CE
CERÁMICO
CERAMIC

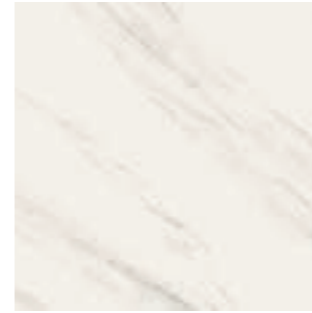

LASA WHITE
ASCALE
2



ABU DHABI
NEOLITH
3



BOTTEGA CALIZA
XTONE
1



PETRA CREMA
INALCO
3

CAT. PRECIO /
PRICE CAT.

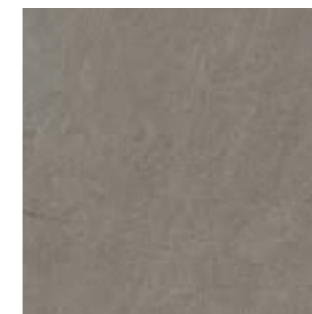

JASPER MOKA
INALCO
3



VIINT
INALCO
3



UMBRA
INALCO
3



ASTANA GREY
XTONE
1

CAT. PRECIO /
PRICE CAT.

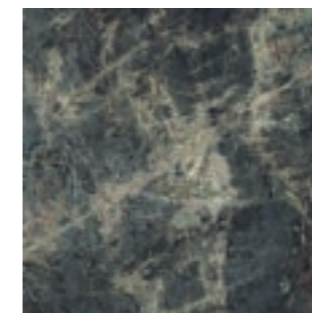

AMAZONIC
NEOLITH
3

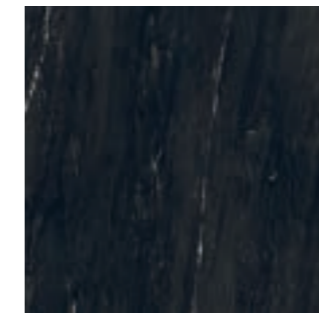

BELVEDERE BLACK
ASCALE
2

CAT. PRECIO /
PRICE CAT.

Cualidades generales de las superficies cerámicas / General qualities of ceramic surfaces



RESISTENTE AL
RAYADO
SCRATCH RESISTANT



INALTERABLE A LAS
BAJAS TEMPERATURAS
UNALTERABLE AT
LOW TEMPERATURES



HECHO EN EUROPA
MADE IN EUROPE



MATERIAL LIGERO
LIGHT WEIGHT



RESISTENTE A ALTAS
TEMPERATURAS
RESISTANT TO HIGH
TEMPERATURES



APTO PARA USO
ALIMENTARIO
SUITABLE FOR FOOD USE



ALTO NIVEL DE MATERIAS
PRIMAS RECICLADAS
HIGH LEVEL OF
RECYCLED
RAW MATERIALS



FÁCIL DE LIMPIAR
EASY TO CLEAN



NO DESPRENDE
SUSTANCIAS NOCIVAS
DOES NOT RELEASE
HARMFUL SUBSTANCES



NO ABSORBENTE
NO ABSORPTION



ALTA RESISTENCIA
SUPERFICIAL
HIGH RESISTANCE



GRAN FORMATO
BIG SIZE

Puede consultar la información técnica específica en la web de cada fabricante:
Specific technical information can be consulted on each manufacturer's website:
www.ascale.es
www.inalco.es
www.xtone-surface.com
www.neolith.com

Cerámicos - Marcas Disponibles / Ceramics - Available Brands

Tabou Design ofrece a sus clientes la posibilidad de montar mesas con cerámicos diferentes a los Colores Estándar. Estas son las marcas con las que trabajamos.

No dude en consultarnos si desea poner en su mesa algún cerámico de cualquiera de ellas y le informaremos de la disponibilidad.

Tabou Design offers its clients the possibility of assembling tables with ceramic tiles other than the Standard Colors. These are the brands we work with.

Do not hesitate to contact us if you want to put a ceramic top from any of them on your table and we will inform you about the availability.

ASCALE



INALCO



XTONE

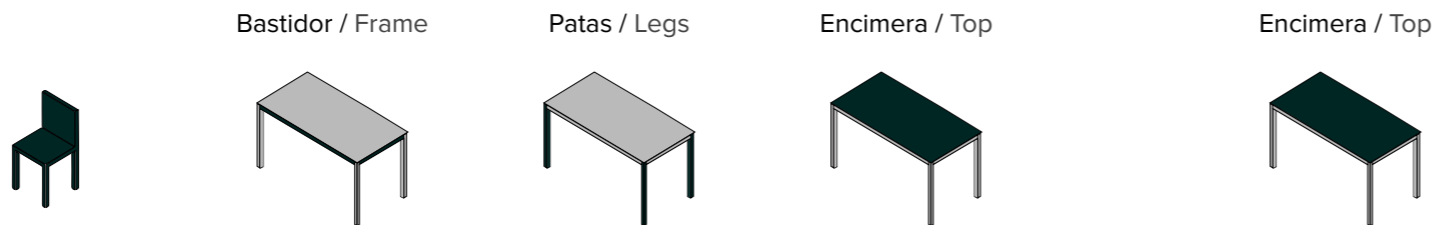

MADERA

En la colección Living de Tabou Design se utiliza como madera principal el Fresno, macizo para las estructuras y rechapado natural en las superficies.

Los acabados son los siguientes:

Tintes Madera / Stained colours:



MFB
FRESNO
ASHWOOD



Lacas Madera Poro Abierto / Lacquered Colours Open Pore

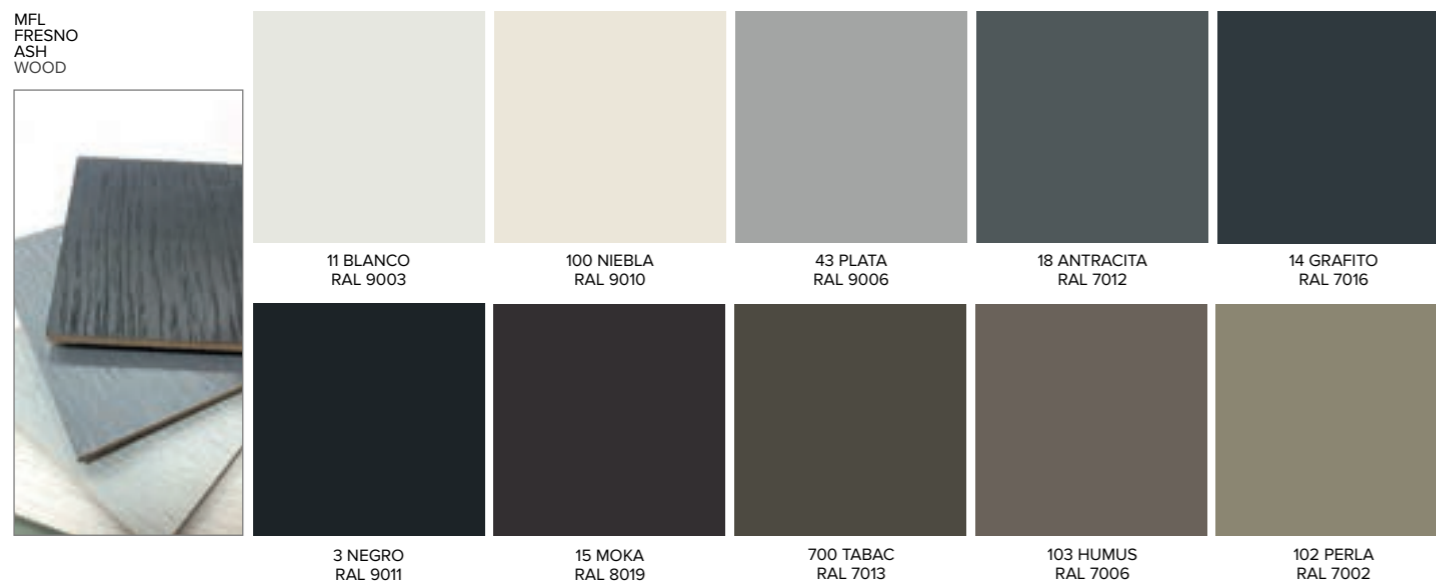

OTRAS MADERAS DISPONIBLE / ANOTHER AVAILABLE WOODS

Tabou ofrece la opción de fabricar las superficies de las mesas en chapa de Roble Natural.

Tabou offers the option of manufacturing table surfaces in Natural Oak.



1334
CHAPA DE ROBLE NATURAL
VENEERED OAKWOOD

WOOD

In the Living collection by Tabou Design, Ash is used as the main wood, solid for the structures and natural veneer on the surfaces.

The finishes are as follows:

FENIX®

Los laminados son productos de revestimiento decorativos. Su estructura se compone de diversas capas de papel impregnadas de resinas que se someten a alta presión y elevada temperatura. Se caracterizan por su excelente diseño, durabilidad y por su resistencia a los golpes y el rallado. Es un material muy utilizado en la fabricación de mobiliario. Además es una superficie higiénica de fácil limpieza y adaptada al uso alimentario.

Fenix es un laminado de tacto sedoso super-mate, anti-huellas y auto-reparable térmicamente

Detalles de fabricación / Manufacturing details

Puede elegir entre 2 acabados para los cantos:

You can choose between 2 finishes for the edges.



Fenix con canto bisel fibracolor negro.
Fenix clad on beveled black mdf

FENIX®

Laminates are decorative coating products. Its structure is made up of various layers of paper impregnated with resins that are subjected to high pressure and high temperature. They are characterized by their excellent design, durability and resistance to shocks and scratches. It is a widely used material in the manufacture of furniture. It is also a hygienic surface that is easy to clean and adapted to food use.

Fenix is a super-matte silky touch, anti-fingerprint and thermally self-repairing laminate



Fenix con canto bisel madera.
Fenix clad on beveled plywood

FE Fenix®

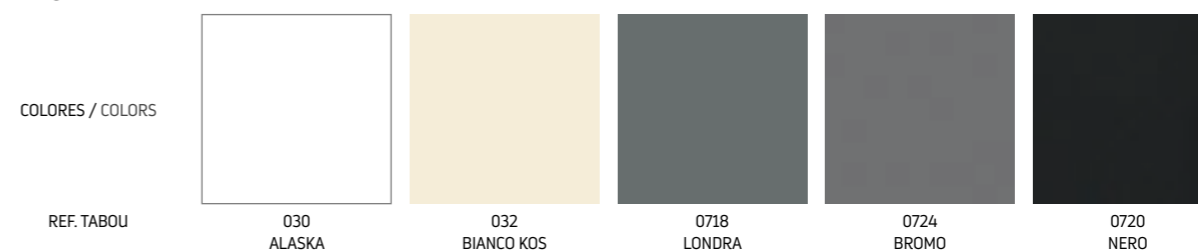

Si desea cualquier otro laminado consulte con fábrica / Consult factory for any other laminate

Encimera / Top



Tapizados / Fabrics

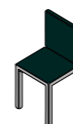

CRISTAL

CA CRISTAL ANTI-RAYAS

Cristal de 6mm, templado, con cuerpo extraclaro para mantener la pureza de las tonalidades, acabado superficial mate con una suave textura y anti-huellas.

Su característica más destacada es su absoluta resistencia al rayado. Color lacado al horno por la cara inferior.

CA Colores / Colors



GLASS

CA ANTI SCRATCH GLASS

6mm tempered glass with an extra-clear body to maintain the purity of the tones, matte surface finish with a smooth texture and anti-fingerprints.

Its most outstanding feature is its absolute resistance to scratching. Oven lacquered color on the underside.

Bastidor / Frame

Patas / Legs

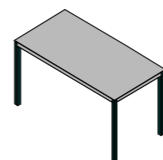
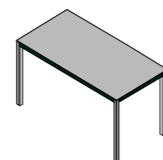

METAL

Hay 2 tipos de acabados metálicos:

ME PINTURA EPOXY

Es un revestimiento metálico de polvo epoxy termolacado que protege de la oxidación. El acabado es mate y micro-texturado lo cuál le da mayor resistencia al roce y le confiere un aspecto moderno y actual.

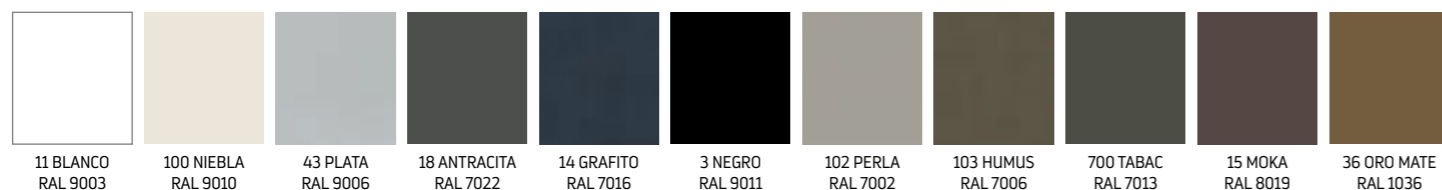

METAL

There are 2 types of metal finishes:

ME EPOXY COATING

It is a metallic coating based on thermo-lacquered epoxy powder that protects against oxidation. The finish is matte and microtextured which gives it greater resistance to friction and gives it a modern and current look.

MB METAL BRILLO

Es un revestimiento metálico brillante, con acabado en Cromo o en Dorado.

Está disponible sólo en los modelos indicados

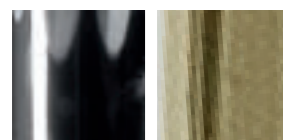

MB GLOSSY METAL

It is a shiny metallic coating, finished in Chrome or Golden. It is available only for the indicated models.

MY MYSTIC

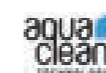

100% PES 450gr/m2 200.000 Martindale. Tela con tacto suave y agradable tratada con tecnología Aquaclean / 100% PES 450gr/m2 200.000 Martindale. Fabric with a soft and pleasant touch treated with Aquaclean technology



Selección de colores de Tabou Design. Puede solicitar cualquier otro color de la colección Mystic o cualquier diseño de Acua Clean. Visite www.acuaclean.com o solicite una muestra.

Tabou Design color selection. You can request any other color from the Maglia collection or any Acua Clean design. Visit www.acuaclean.com or request a sample

LIBRA crevin

50%PP 32% PES 12% CO 6% OF REC. 440gr/m2. 66.000 Martindale

LIBRA proporciona un suave tacto y una gran resistencia al desgaste. Es un tejido especialmente adecuado para interiores soleados, duradero y de fácil limpieza. Para ver la colección completa y más detalles técnicos: <https://www.crevin.com/es/detail/libra>

LIBRA provides a soft touch and great resistance to wear. It is a fabric especially suitable for sunny interiors, durable and easy to clean. To see the complete collection and more technical details: <https://www.crevin.com/es/detail/libra>

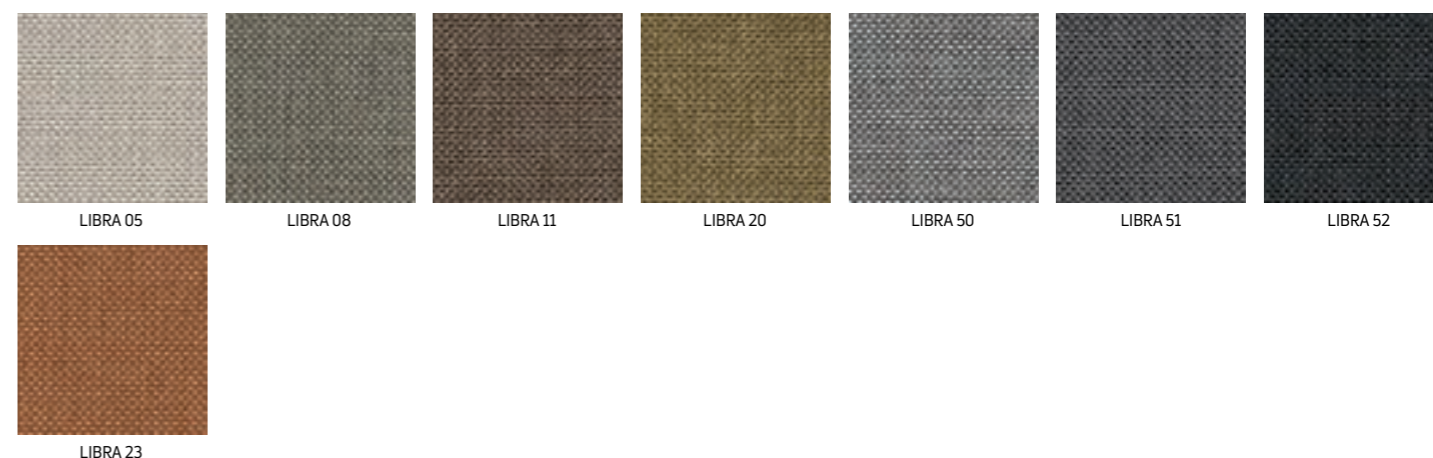

Tapizados / Fabrics

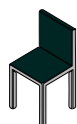

BRUNEI + FROCA



100% PES. 290gr/m2. 30.000 Martindale

Brunei es un tejido con brillo y tacto terciopelo. Con gran resistencia al desgaste y defácil limpieza gracias a la protección del Teflon. Para ver la colección completa y más detalles técnicos: <https://froca.com/brunei-ficha/>

Brunei is a fabric with shine and velvet touch. With great resistance to wear and easy cleaning thanks to Teflon protection. To see the complete collection and more technical details: <https://froca.com/brunei-ficha/>



BRUNEI 01 BRUNEI 02 BRUNEI 04 BRUNEI 31 BRUNEI 33 BRUNEI 40 BRUNEI 08



BRUNEI 14

ALBA aqua clean

100% PES REC. 511gr/m2. 35.000 Martindale

ALBA recoge las últimas tendencias . Una amplia gama de colores jaspeados tacto suave y dulce con tecnología Aquaclean

Para ver la colección completa y más detalles técnicos: <https://www.aquaclean.com/es-es/contract#collections>

ALBA collects the latest trends. A wide range of marbled colors, soft and sweet touch with Aquaclean technology

To see the complete collection and more technical details: <https://www.aquaclean.com/es-es/contract#collections>



56 90 09 11 27 271 300



407 357 30

Tapizados / Fabrics



CAMILA aqua clean

73% PES, 21% PESREC, 5% COTREC, 1% POLIAM. 482gr/m2. 50.000 Martindale

CAMILA recoge las últimas tendencias. Una amplia gama de colores jaspeados tacto suave y dulce con tecnología Aquaclean

Para ver la colección completa y más detalles técnicos: <https://www.aquaclean.com/es-es/contract#collections>

CAMILA collects the latest trends. A wide range of marbled colors, soft and sweet touch with Aquaclean technology

To see the complete collection and more technical details: <https://www.aquaclean.com/es-es/contract#collections>



100 51 248 1248 10 300 314

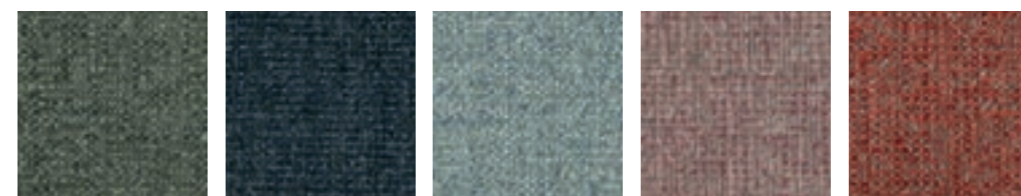

407 60 347 324 305

tabou.TM DESIGN
LIVING COLLECTION

